



SUNNDA CORPORATION

Go Above & Beyond



Sunnda Corporation

Headquartered in the energy capital of the world - Houston, Texas, Sunnda Corporation designs, manufactures, and markets an extensive line of oilfield equipment, which meets or exceeds the rigorous industry standards established by the American Petroleum Institute (API) and the International Standards Organization (ISO). As a global supplier of quality oilfield equipment to the oil and gas industry, we ship our products around the globe. These are our major categories:

- DRILLING PRODUCTS
- PRODUCTION PRODUCTS
- OILFIELD SERVICE PRODUCTS

To see our complete product line, please visit our website <http://www.sunnda.com> or download our composite catalog.

Sunnda knows the various needs of the oilfield service companies and operators worldwide. One important thing about us is that we are able to supply quality products to our customers with competitive prices. Customers who buy equipment from us can benefit from great savings and get their products in time.



Table of Contents

Drilling Products

Drilling Rigs	2
Skid-Mounted Drilling Rigs.....	2
Truck-Mounted Drilling Rigs.....	6
Trailer-Mounted Drilling Rigs.....	7
Mud Pump Parts & Expendables	8
Triplex Mud Pumps	9
SDF-500 Triplex Mud Pumps.....	9
SDF-800 Triplex Mud Pumps.....	10
SDF-1000 Triplex Mud Pumps.....	11
SDF-1300 Triplex Mud Pumps.....	12
SDF-1600 Triplex Mud Pumps.....	13
SDF-2200 Triplex Mud Pumps.....	14
SDP-1000 Triplex Mud Pumps.....	15
SDP-550 Triplex Mud Pumps.....	16
SD-EW-446 Triplex Mud Pumps.....	17
Pressure Control Equipment	18
Annular Blowout Preventers.....	18
Ram Blowout Preventers.....	19
Diverter.....	20
BOP Control Systems.....	21
Choke & Kill Manifolds.....	22
Spools & DSAs.....	23
BOP Parts.....	23
Drill Bits	24
Top Drives	25
Handling Tools	26
Drilling Equipment	27
Masts.....	27
Substructures.....	27
Drawworks.....	28
Crown Blocks.....	29
Hook Blocks.....	30
Traveling Blocks.....	31
Hooks.....	32
Rotary Tables.....	33
Swivels.....	34

Drilling Motors.....	35
Downhole Tools	36
Oil Country Tubular Goods	37
Drill Pipe.....	37
Heavy Weight Drill Pipes.....	40
Drill Collars.....	41
Seamless Casing.....	42
ERW Casing.....	45
Tubing.....	46

Production Products

Wellheads & Christmas Tree Components	47
FC Gate Valves.....	47
Gate Valve Replacement Parts.....	48
M Expanding Gate Valves.....	49
Chokes.....	49
Casing Heads C-22/C-29.....	50
Casing Spools C-22/C-29.....	52
Tubing Heads & Spools TCM.....	54
Tubing Head Adapters.....	55
Crosses & Tees.....	56
Christmas Tree Caps.....	57
Flanges.....	58
Pumping Units	60
Crank Balanced Pumping Units.....	60
Beam Balanced Pumping Units.....	62
Sucker Rods & Rod Pumps.....	63

Oilfield Service Products

Frac Components	64
Flowline Products	65
Workover Rigs	66
Onshore Workover Rigs.....	66
Offshore Workover Rigs.....	68
Well Service Pumps	69
Cementing Equipment	70
Fracturing Equipment	71
Line Pipes	72



Drilling Products

Drilling Rigs

Skid-Mounted Drilling Rigs

AC/VFD Drive Drilling Rigs

Model	SDR-1000AC	SDR-1500AC	SDR-2000AC	SDR-3000AC
Drilling Depth (4-1/2" Drill Pipe), ft	13,000	16,000	23,000	30,000
Static Hook Load, lbs	500,000	750,000	1,000,000	1,500,000
Number of Lines Stung to The Traveling Block	10	12	12	14
Diameter of Drilling Line, in	1-1/4	1-3/8	1-1/2	1-3/4
Drawworks Rated Power, HP	1,000	1,500	2,000	3,000
Main Brake	Hydraulic Disc Brake	Hydraulic Disc Brake	Hydraulic Disc Brake	Hydraulic Disc Brake
Auxiliary Brake	Eddy Current Brake	Eddy Current Brake	Eddy Current Brake	Eddy Current Brake
Mast Type	Cantilever/Bootstrap	Cantilever	Cantilever	Cantilever
Mast Height, ft	141	148	148	158
Substructure Type	Box-on-Box/ Slingshot	Box-on-Box/ Slingshot/ Swing-lift	Slingshot/ Swing-lift	Swing-lift
Substructure Height, ft	25	29.5	34.5	40
Clear Height Under Rotary Beam, ft	20	25	29.5	33
Rotary Table	27½"	37½"	37½"	49½"
Mud Pumps	F-1000 x 2	F-1600 x 2	F-1600 x 3	F-1600 x 3



DC/SCR Drive Drilling Rigs

Model	SDR-1000DC	SDR-1500DC	SDR-2000DC	SDR-3000DC
Drilling Depth (4-1/2" Drill Pipe), ft	13,000	16,000	23,000	30,000
Static Hook Load, lbs	500,000	750,000	1,000,000	1,500,000
Number of Lines Stung to The Traveling Block	10	12	12	14
Diameter of Drilling Line, in	1-1/4	1-3/8	1-1/2	1-3/4
Drawworks Rated Power, HP	1,000	1,500	2,000	3,000
Main Brake	Hydraulic Disc Brake	Hydraulic Disc Brake	Hydraulic Disc Brake	Hydraulic Disc Brake
Auxiliary Brake	Eddy Current Brake	Eddy Current Brake	Eddy Current Brake	Eddy Current Brake
Mast Type	Cantilever/ Bootstrap	Cantilever	Cantilever	Cantilever
Mast Height, ft	141	148	148	158
Substructure Type	Box-on-Box/ Slingshot	Box-on-Box/ Slingshot/ Swing-lift	Slingshot/ Swing-lift	Swing-lift
Substructure Height, ft	25	29.5	34.5	40
Clear Height Under Rotary Beam, ft	20	25	29.5	33
Rotary Table	27½"	37½"	37½"	49½"
Hook Block, lbs	500,000	750,000	1,000,000	1,500,000
Swivel, lbs	500,000	750,000	1,000,000	1,500,000
Mud Pumps	F-1000 x 2	F-1600 x 2	F-1600 x 3	F-1600 x 3





Mechanical Drive Drilling Rigs

Model	SDR-1000M	SDR-1500M	SDR-2000M
Drilling Depth (4-1/2" Drill Pipe), ft	13,000	16,000	23,000
Static Hook Load, lbs	500,000	750,000	1,000,000
Number of Lines Stung to The Traveling Block	10	12	12
Diameter of Drilling Line, in	1-1/4	1-3/8	1-1/2
Drawworks Rated Power, HP	1,000	1,500	2,000
Main Brake	Hydraulic Disc Brake	Hydraulic Disc Brake	Hydraulic Disc Brake
Auxiliary Brake	Eddy Current Brake	Eddy Current Brake	Eddy Current Brake
Mast Type	Cantilever/Bootstrap	Cantilever	Cantilever
Mast Height, ft	141	148	148
Substructure Type	Box-on-Box/ Slingshot	Box-on-Box/ Slingshot/ Swing-lift	Slingshot/ Swing-lift
Substructure Height, ft	25	29.5	34.5
Clear Height Under Rotary Beam, ft	20	25	29.5
Rotary Table	27½"	37½"	37½"
Hook Block, lbs	500,000	750,000	1,000,000
Swivel, lbs	500,000	750,000	1,000,000
Mud Pumps	F-1000 x 2	F-1600 x 2	F-1600 x 3



Compound Drive Drilling Rigs

Model	SDR-1000MC	SDR-1500MC	SDR-2000MC
Drilling Depth (4-1/2" Drill Pipe), ft	13,000	16,000	23,000
Static Hook Load, lbs	500,000	750,000	1,000,000
Number of Lines Stung to The Traveling Block	10	12	12
Diameter of Drilling Line, in	1-1/4	1-3/8	1-1/2
Drawworks Rated Power, HP	1,000	1,500	2,000
Main Brake	Hydraulic Disc Brake	Hydraulic Disc Brake	Hydraulic Disc Brake
Auxiliary Brake	Eddy Current Brake	Eddy Current Brake	Eddy Current Brake
Mast Type	Cantilever/Bootstrap	Cantilever	Cantilever
Mast Height, ft	141	148	148
Substructure Type	Box-on-Box/Slingshot	Box-on-Box/Slingshot/Swing-lift	Slingshot/Swing-lift
Substructure Height, ft	25	29.5	34.5
Clear Height Under Rotary Beam, ft	20	25	29.5
Rotary Table	27½"	37½"	37½"
Hook Block, lbs	500,000	750,000	1,000,000
Swivel, lbs	500,000	750,000	1,000,000
Mud Pumps	F-1000 x 2	F-1600 x 2	F-1600 x 3

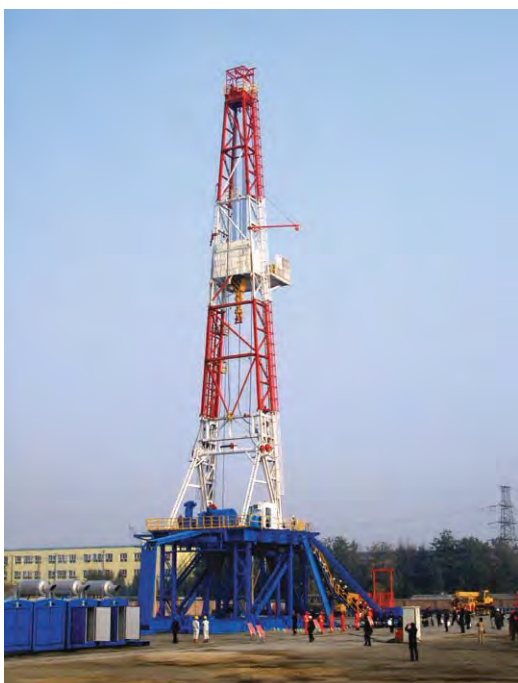



Truck-Mounted Drilling Rigs



Model	SDR-450TK	SDR-550TK	SDR-650TK	SDR-750TK	SDR-1000TK
Drilling Depth (4-1/2" Drill Pipe), ft	3,300	5,000	6,600	10,000	13,000
Workover Depth (3-1/2" Drill Pipe), ft	11,500	13,000	18,000	21,000	24,600
Static Hook Load, lbs	250,000	300,000	350,000	400,000	500,000
Number of Lines Stung to The Traveling Block	8	8	8	8/10	10
Diameter of Drilling Line, in	1	1	1-1/8	1-1/4	1-1/4
Carrier	10 x 8	10 x 8	12 x 8	14 x 8	14 x 10
Drawworks Rated Power, HP	450	550	650	750	1,000
Engine	Caterpillar C-13	Caterpillar C-15	Caterpillar C-18	Caterpillar C-15 x 2	Caterpillar C-18 x 2
Transmission	Allison S5610	Allison S5610	Allison S6610	Allison S5610 x 2	Allison S6610 x 2
Main Brake	Band/Disc	Band/Disc	Band/Disc	Band/Disc	Disc
Auxiliary Brake	Eaton WCB	Eaton WCB	Eaton WCB	Eaton WCB	Eaton WCB
Mast Type	Telescoping	Telescoping	Telescoping	Telescoping	Telescoping
Mast Height, ft	102	108	115	118/125	118/125
Substructure Type	Telescoping	Telescoping	Telescoping	Foldable	Foldable
Substructure Height, ft	12	15	15	20	20
Rotary Table	17½"	17½"	17½"	20½"/27½"	27½"
Hook Block Load, lbs	250,000	300,000	350,000	400,000	500,000
Swivel Load, lbs	250,000	300,000	350,000	400,000	500,000

Trailer-Mounted Drilling Rigs



Model	SDR-550TL	SDR-650TL	SDR-750TL	SDR-1000TL
Drilling Depth (4-1/2" Drill Pipe), ft	5,000	6,600	10,000	13,000
Workover Depth (3-1/2" Drill Pipe), ft	13,000	18,000	21,000	24,600
Static. Hook Load, lbs	300,000	350,000	400,000	500,000
Number of Lines Stung to The Traveling Block	8	8	8/10	10
Diameter of Drilling Line, in	1	1-1/8	1-1/4	1-1/4
Drawworks Rated Power, HP	550	650	750	1,000
Engine	Caterpillar C-15	Caterpillar C-18	Caterpillar C-15 x 2	Caterpillar C-18 x 2
Transmission	Allison S5610	Allison S6610	Allison S5610 x 2	Allison S6610 x 2
Main Brake	Band/Disc	Band/Disc	Band/Disc	Band/Disc
Auxiliary Brake	Eaton WCB	Eaton WCB	Eaton WCB	Eaton WCB
Mast Type	Telescoping	Telescoping	Telescoping	Telescoping
Mast Height, ft	108	115	118/125	118/125
Substructure Type	Telescoping	Telescoping	Foldable	Foldable
Substructure Height, ft	15	15	20	20
Rotary Table	17½"	17½"	20½"/27½"	27½"
Hook Block Load, lbs	300,000	350,000	400,000	500,000
Swivel Load, lbs	300,000	350,000	400,000	500,000



Mud Pump Parts & Expendables

High chrome sleeve liners, zirconia ceramic liners, urethane bonded pistons with long service life, high temperature and plate type design valves and seats available in API 4 thru 8 sizes to fit all major mud pumps, a complete line of urethane bonded pistons, replaceable rubber pistons, rubber bonded pistons, a full range of full open, 3 web, 4 web interchangeable fluid end modules and accessories, for various OEM's mud pumps such as National, Emsco, Gardner Denver, Bomco, Ideco and Oilwell etc.



High Chrome Liners



Ceramic Liners



Urethane-Bonded Pistons



Rubber Pistons



Module



Valves and Seats

Triplex Mud Pumps

SDF-500 Triplex Mud Pumps (API-7K)

Specifications

Rated Horsepower: 500 HP
 Rated Pump Speed: 165 SPM
 Maximum Liner Size by Stroke Length: 6-3/4" x 7-1/2"
 Suction Connection: 8"
 Discharge Connection: 4" 5,000 psi Flange
 Gear Ratio: 4.286:1
 Valve Pot: API #5
 Approximate Weight: 21,539 lbs



Performance

Liner Size, inches	6-3/4	6-1/2	6	5-1/2	5	4	
Rated Pressure, psi	1,342	1,447	1,699	2,020	2,442	3,820	
Pump Speed SPM	Input Power HP	Displacement, GPM					
165	500	575	533	454	382	316	202
150	455	523	485	413	347	287	184
140	424	488	452	386	324	268	171
130	394	453	420	358	301	249	159
120	364	418	388	330	278	229	147
110	334	383	356	303	255	210	135
Volume/Stroke, gallons	3.49	3.23	2.75	2.31	1.91	1.22	

Ratings are based on 90% mechanical efficiency and 100% volumetric efficiency.



SDF-800 Triplex Mud Pumps (API-7K)

Specifications

Rated Horsepower: 800 HP
 Rated Pump Speed: 150 SPM
 Maximum Liner Size
 by Stroke Length: 6-3/4" x 9"
 Suction Connection: 10"
 Discharge Connection: 5-1/8" 5,000 psi Flange
 Gear Ratio: 4.207:1
 Valve Pot: API #6
 Approximate Weight: 31,967 lbs



Performance

Liner Size, inches	6-3/4	6-1/2	6	5-1/2	5	4	
Rated Pressure, psi	1,969	2,122	2,490	2,962	3,588	5,000	
Pump Speed SPM	Input Power HP		Displacement, GPM				
150	800	627	582	496	417	344	220
140	747	586	543	463	389	321	206
130	694	544	504	430	361	298	191
120	640	502	465	397	333	275	176
110	587	460	427	364	305	252	162
100	533	418	388	330	278	229	147
Volume/Stroke, gallons	4.18	3.88	3.30	2.78	2.29	1.47	

Ratings are based on 90% mechanical efficiency and 100% volumetric efficiency.

SDF-1000 Triplex Mud Pumps (API-7K)

Specifications

Rated Horsepower: 1,000 HP
 Rated Pump Speed: 140 SPM
 Maximum Liner Size by Stroke Length: 6-3/4" x 10"
 Suction Connection: 10"
 Discharge Connection: 5-1/8" 5,000 psi Flange
 Gear Ratio: 4.207:1
 Valve Pot: API #6
 Approximate Weight: 41,425 lbs



Performance

Liner Size, inches	6-3/4	6-1/2	6	5-1/2	5	4	
Rated Pressure, psi	2,370	2,558	3,000	3,572	4,322	5,000	
Pump Speed SPM	Input Power HP	Displacement, GPM					
140	1,000	651	603	514	432	357	289
130	928	604	560	477	401	331	269
120	857	558	517	441	370	306	248
110	785	511	474	404	339	280	227
100	714	465	431	367	309	255	207
90	642	418	388	330	278	229	186
Volume/Stroke, gallons	4.65	4.31	3.67	3.09	2.55	2.07	

Ratings are based on 90% mechanical efficiency and 100% volumetric efficiency.



SDF-1300 Triplex Mud Pumps (API-7K)

Specifications

Rated Horsepower: 1,300 HP
 Rated Pump Speed: 120 SPM
 Maximum Liner Size by Stroke Length: 7" x 12"
 Suction Connection: 12"
 Discharge Connection: 5-1/8" 5,000 psi Flange
 Gear Ratio: 4.206:1
 Valve Pot: API #7
 Approximate Weight: 54,171 lbs



Performance

Liner Size, inches	7	6-3/4	6-1/2	6	5-1/2	5	
Rated Pressure, psi	2,786	2,998	3,232	3,792	4,516	5,000	
Pump Speed SPM	Input Power HP		Displacement, GPM				
120	1,300	720	669	621	529	444	367
110	1,192	660	613	569	485	407	337
100	1,083	600	558	517	441	370	306
90	975	540	502	465	397	333	275
80	867	480	446	414	353	296	245
70	758	420	390	362	308	259	214
Volume/Stroke, gallons	6.00	5.58	5.17	4.41	3.70	3.06	

Ratings are based on 90% mechanical efficiency and 100% volumetric efficiency.

SDF-1600 Triplex Mud Pumps (API-7K)

Specifications

Rated Horsepower: 1,600 HP
 Rated Pump Speed: 120 SPM
 Maximum Liner Size by Stroke Length: 7" x 12"
 Suction Connection: 12"
 Discharge Connection: 5-1/8" 5,000 psi Flange
 Gear Ratio: 4.206:1
 Valve Pot: API #7
 Approximate Weight: 54,655 lbs



Performance

Liner Size, inches	7	6-3/4	6-1/2	6	5-1/2	5	
Rated Pressure, psi	3,430	3,690	3,978	4,668	5,000	5,000	
Pump Speed SPM	Input Power HP	Displacement, GPM					
120	1,600	720	669	621	529	444	367
110	1,467	660	613	569	485	407	337
100	1,334	600	558	517	441	370	306
90	1,200	540	502	465	397	333	275
80	1,067	480	446	414	353	296	245
70	933	420	390	362	308	259	214
Volume/Stroke, gallons	6.00	5.58	5.17	4.41	3.70	3.06	

Ratings are based on 90% mechanical efficiency and 100% volumetric efficiency.



SDF-2200 Triplex Mud Pumps (API-7K)

Specifications

Rated Horsepower: 2,200 HP
 Rated Pump Speed: 105 SPM
 Maximum Liner Size by Stroke Length: 9" x 14"
 Suction Connection: 12"
 Discharge Connection: 5-1/8" 5,000 psi Flange
 Gear Ratio: 3.512:1
 Valve Pot: API #8
 Approximate Weight: 64,815 lbs



Performance

Liner Size, inches	9	8-1/4	7-1/2	7	6	5-1/2	
Rated Pressure, psi	2,760	3,310	4,040	4,505	5,000	5,000	
Pump Speed SPM	Input Power HP	Displacement, GPM					
105	2,200	1,231	1,026	840	754	524	456
90	1,886	1,055	880	720	646	449	391
80	1,676	938	782	640	574	399	347
70	1,467	820	684	560	503	349	304
60	1,257	703	586	480	431	299	261
50	1,048	586	489	400	359	249	217
Volume/Stroke, gallons	11.72	9.77	8.00	7.18	4.99	4.34	

Ratings are based on 90% mechanical efficiency and 100% volumetric efficiency.

SDP-1000 Triplex Mud Pumps (API-7K)

Specifications

Rated Horsepower: 1,000 HP
 Rated Pump Speed: 130 SPM
 Stroke Length: 9"
 Maximum Liner Size: 7"
 Piston Load : 101,550 lbs
 Gear Ratio: 4.48:1
 Approximate Weight: 24,800 lbs



Performance

Liner Size, inches	Displacement		Maximum Pressure, psi	Pump RPM	JackShaft RPM
	Gallon Per Revolution	Gallon Per Minute			
7	4.5	585	2,639	130	582
6-1/2	3.88	504	3,060		
6-1/4	3.59	466	3,310		
6	3.30	430	3,592		
5-1/2	2.78	361	4,274		
5	2.29	298	5,000		
4-1/2	1.86	242	5,000		
4	1.47	191	5,000		

Ratings are based on 90% mechanical efficiency and 100% volumetric efficiency.



SDP-550 Triplex Mud Pumps (API-7K)

Specifications

Rated Horsepower: 550 HP
 Rated Pump Speed: 145 SPM
 Stroke Length: 7"
 Maximum Liner Size: 7"
 Piston Load : 64,400 lbs
 Gear Ratio: 4.625:1
 Approximate Weight: 16,780 lbs

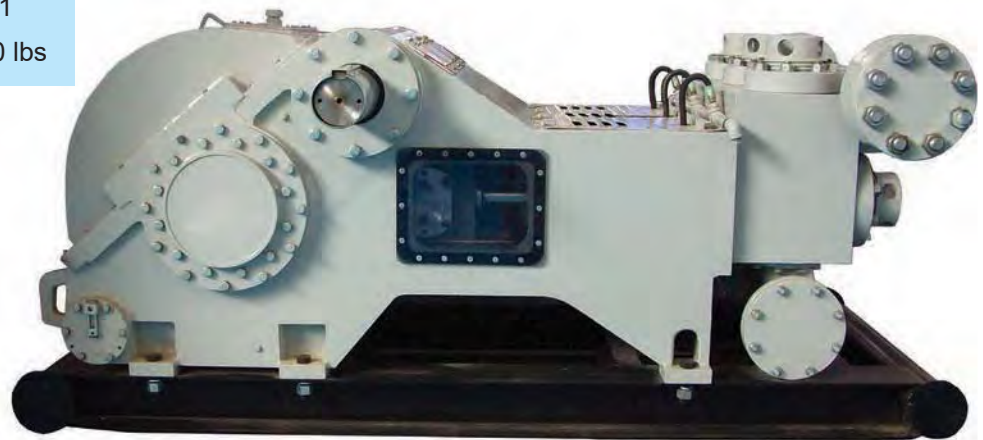

Performance

Liner Size, inches	Displacement		Maximum Pressure, psi	Pump RPM	JackShaft RPM
	Gallon Per Revolution	Gallon Per Minute			
7	3.5	507	1,673	145	670
6-1/2	3.02	437	1,940		
6-1/4	2.78	404	2,100		
6	2.57	373	2,277		
5-1/2	2.16	313	2,710		
5	1.78	259	3,279		
4-1/2	1.45	210	4,048		
4	1.14	166	5,000		

Ratings are based on 90% mechanical efficiency and 100% volumetric efficiency.

SD-EW-446 Triplex Mud Pumps (API-7K)

Specifications

Rated Horsepower: 440 HP
 Rated Pump Speed: 320 SPM
 Stroke Length: 6"
 Suction Inlet: 150 flange 6"
 Discharge Outlet: 900 flange 3"
 Gear Ratio: 4.578:1
 Valve Pot: API #4
 Dimensions: 98" x 48" x 44"
 Approximate Weight: 9,840 lbs



SD-EW-446 Performance

Liner Size, inches	6	5-1/2	5	4-1/2	4	3-1/2	
Rated Pressure, psi	1,027	1,222	1,479	1,710	2,169	2,816	
Pump Speed SPM	Input Power HP	Displacement, GPM					
320	440	661	555	459	397	313	240
270	380	551	463	382	335	264	202
220	320	441	370	306	273	215	165
170	260	330	278	229	211	167	127
120	200	220	185	153	149	118	90
70	200	110	93	76	87	69	52
Volume/Stroke, gallons	2.203	1.851	1.530	1.239	0.979	0.750	

Ratings are based on 90% mechanical efficiency and 100% volumetric efficiency.



Pressure Control Equipment

Annular Blowout Preventers (API-16A)

Type S and type G annular blowout preventers: sizes and models are in the table below. Type S annular blowout preventers have bolted-cover and wedge-cover; type G annular type blowout preventers have screwed-head and latched-head. Our blowout preventers are manufactured in accordance with API Specification 16A, Third Edition and NACE MR0175 per API Specification 16A, Temperature T20. They meet the applicable API and NACE requirements for H2S service.



Annular BOP Sizes and Models

Working Pressure (psi)	Bore (inches)							
	7-1/16	9	11	13-5/8	16-3/4	18-3/4	20-3/4	21-1/4
10,000								
5,000								
3,000								
2,000								

Annular BOP Specifications*

Bore (inches)	7-1/16		9		11		13-5/8		20-3/4		21-1/4	
Working Pressure (psi)	3,000	5,000	3,000	5,000	3,000	5,000	10,000	3,000	5,000	10,000	3,000	2,000
Operating Pressure (psi)	1,500	1,500	1,500	1,500	1,500	1,500	1,500	1,500	1,500	1,500	1,500	1,500
Gallons to Close	4.92	4.57	7.23	11.05	11.00	18.67	30.58	23.50	23.58	40.16	43.40	31.10
Gallons to Open	3.43	3.21	5.03	8.72	6.78	14.95	24.67	14.67	17.41	32.64	26.90	18.90
Width (inches)	29	29	35-1/2	40	39-7/8	44-3/4	57	46-3/8	50	64-1/2	54-1/8	52-3/4
Height (inches), Studded Top, Flanged Bottom	29-1/8	30-7/8	32-1/2	36-1/2	32-7/8	41-1/2	53	40-11/16	44-15/16	58-3/4	48-7/16	52-1/2
Weight (lbs), Studded Top, Flanged Bottom	2,900	3,175	4,775	6,800	5,825	9,550	23,000	9,100	13,650	32,475	14,600	15,100
Ring Gasket	R-45	R-46	R-49	R-50	R-53	R-54	BX-158	R-57	BX-160	BX-159	R-74	R-73

*This is only a partial listing of our ram blowout preventers. Data in this table are for reference only.

Ram Blowout Preventers (API-16A)

LWP, LWS, SL/SLX, LXT style, and type U style ram blowout preventers; their sizes, models and technical specifications are in the following tables. Our blowout preventers are manufactured in accordance with API Specification 16A, Third Edition and NACE MR0175 per API Specification 16A, Temperature T20. They meet the applicable API and NACE requirements for H2S service.

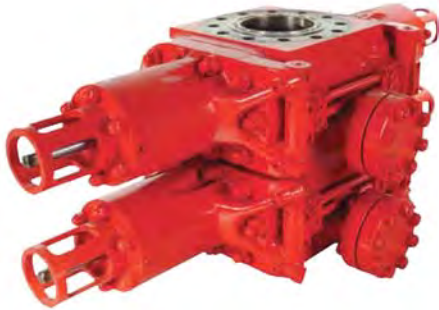

Ram BOP Sizes and Models

Working Pressure (psi)	Bore (inches)								
	7-1/16	9	11	13-5/8	16-3/4	18-3/4	20-3/4	21-1/4	26-3/4
15,000									
10,000									
5,000									
3,000									
2,000									

LWP, LWS, SL/SLX Style Ram BOP Specifications *

Bore (inches)	7-1/16		9		11		13-5/8		20-3/4	21-1/4		
Working Pressure (psi)	5,000	10,000	3,000	5,000	3,000	5,000	10,000	3,000	5,000	10,000	3,000	2,000
Length (inches)	58-1/4	79	60	79-1/8	72-5/8	89-1/4	122-3/4	130-1/4	130-1/4	128-3/4	127-1/2	127-1/2
Width (inches)	21-1/2	30	21-1/2	23-1/16	25-15/16	28-3/4	38-9/16	40-3/4	40-3/4	43-1/16	41-1/4	40-7/8
Height (inches), Single, Stud x Stud	15	22-7/8	11-1/8	14-1/2	14-1/2	19-1/2	23-1/2	17-1/4	17-1/4	28	23-1/8	23-1/8
Height (inches), Double, Stud x Stud	26-3/4	36-5/8	22	29-1/2	29-3/8	33	40-7/8	34	34	46	49-1/4	44-7/16
Weight (lbs), Single, Stud x Stud	1,385	5,550	1,170	2,870	2,116	4,150	11,100	8,400	8,800	13,200	7,448	7,285
Weight (lbs), Double, Stud x Stud	2,504	9,900	2,200	5,750	4,096	7,725	20,560	15,350	15,620	23,400	14,615	14,455
Gallons to Open	1.18	2.34	0.68	2.27	1.45	2.62	7.0	4.46	4.46	10.52	4.46	4.46
Gallons to Close	1.45	2.72	0.77	2.58	1.74	2.98	9.45	5.44	5.44	10.58	5.07	5.07
Closing Ratio	5.45:1	7.11:1	4.5:1	5.57:1	5.45:1	5.57:1	7.11:1	5.54:1	5.54:1	7.11:1	5.57:1	5.57:1

*This is only a partial listing of our ram blowout preventers. Data in this table are for reference only.



Type U Style Ram BOP Specifications *

Bore (inches)	7-1/16		11				13-5/8				20-3/4	21-1/4
Working Pressure (psi)	5,000	10,000	3,000	5,000	10,000	15,000	3,000	5,000	10,000	15,000	3,000	2,000
Length (inches)	74	74	95.25	96.25	96.25	124	112.13	112.13	114.13	139.00	143.69	143.69
Width (inches)	20.25	20.63	25.13	25.13	25.75	32	29.25	29.25	30.25	39.50	39.52	39.52
Height (inches), Single, Flange x Flange	27.50	30.56	29.06	34.31	35.69	44.81	31.31	33.81	41.69	53.69	40.56	37.9
Height (inches), Double, Flange x Flange	44.19	48.63	49.25	54.50	55.88	69.75	53.38	55.88	66.63	81.75	66.13	62.75
Weight (lbs), Single, Flange x Flange	2,800	3,550	5,300	5,600	6,400	10,300	7,200	7,700	10,300	23,700	13,650	13,250
Weight (lbs), Double, Flange x Flange	5,200	6,400	9,900	10,200	11,300	18,400	14,300	14,800	18,400	43,250	25,550	25,150
Locking Screw Turns (Each End)	18	18	27	27	27	32	32	32	32	45	46	46
Gallons to Open	1.3	1.3	3.4	3.4	3.4	5.7	5.5	5.5	5.5	10.4	8.1	9.0
Gallons to Close	1.3	1.3	3.5	3.5	3.5	5.8	5.8	5.8	5.8	10.6	8.7	8.7
Closing Ratio	6.9:1	6.9:1	7.3:1	7.3:1	7.3:1	9.8:1	7.0:1	7.0:1	7.0:1	10.6:1	7.0:1	7.0:1

Diverters

29-1/2", 500 psi diverters.



BOP Control Systems (API-16D)

We supply a wide range of BOP closing units; the number of control object is from 1 to 14.





Choke and Kill Manifolds (API-16C)

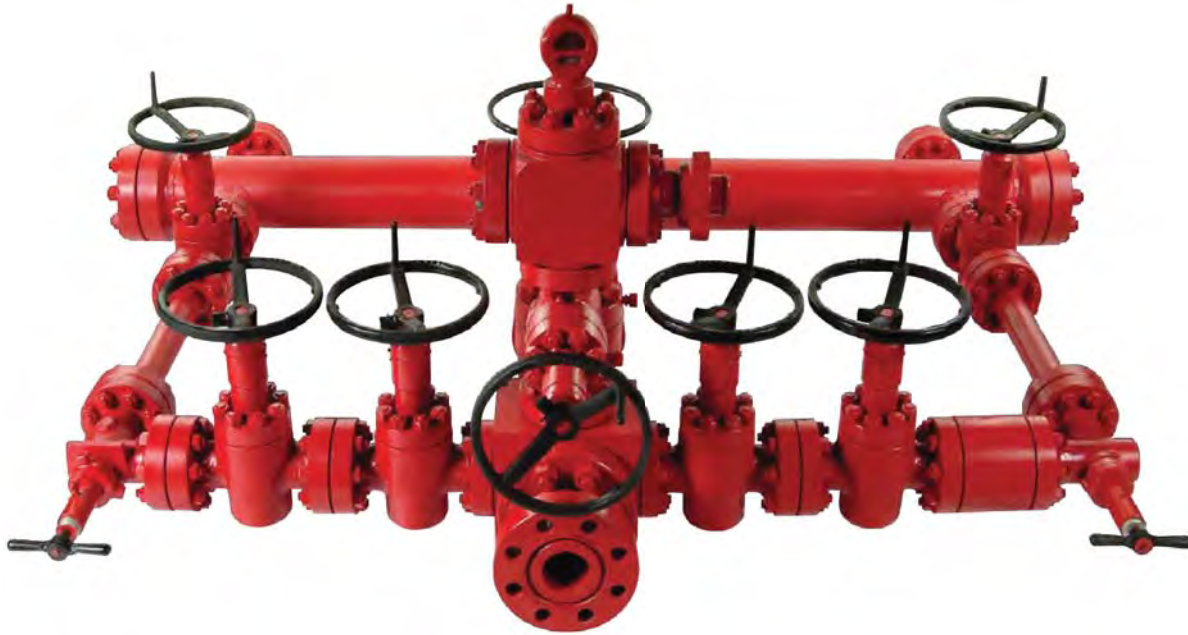

Model	Working Pressure	Inlet	Outlet	Valve Control
CM3	3,000 psi	3-1 / 8 " - 3,000 psi	3-1 / 8 " - 3,000 psi	Manual and Hydraulic
CM5	5,000 psi	3-1 / 8 " - 5,000 psi	3-1 / 8 " - 3,000 psi	Manual and Hydraulic
CM10	10,000 psi	3-1 / 16 " - 10,000 psi	3-1 / 8 " - 5,000 psi	Manual and Hydraulic
CM15	15,000 psi	3-1 / 16 " - 15,000 psi	3-1 / 16 " - 10,000 psi	Manual and Hydraulic

Notes:

Working Temperature: -20 - 250 °F
 Material Class: AA BB CC DD EE FF
 Working Medium: Mud, Petroleum, Natural Gas.

Specification Level: PSL1 - PSL4
 Performance Level: PR1 - PR2

Spools & DSAs

Drilling spools, spacer spools, adapter spools, double studed adapters (DSA) in various sizes and pressures.



Drilling Spool



Spacer Spool



DSA

BOP Parts

Annular and ram BOP parts for all the popular OEMs - packing elements, ram assemblies, ram blocks, ram rubbers, etc.



Packing Element



Packing Element



Ram Blocks



Ram Blocks



Ram Blocks



Ram Rubber



Drill Bits (API-7-1)

Roller cone bits, PDC (steel-body and matrix-body) bits, diamond-impregnated bits, and PDC coring bits.



Matrix Body PDC Bit



Steel Body PDC Bit



Diamond-impregnated Bit



Matrix Body PDC Bit



PDC Coring Bit



Roller Cone Bit

Top Drives

A full line of AC electric top drives from 250 to 1,000 tons. Our model TD-250AC top drive is specifically designed for mobile drilling rigs. We know that short lead time is important for the drilling contractors. Most of our top drives can be delivered to the customers in a timely manner so that their drilling needs are met in time.

Drilling efficiency and safety are our primary objectives. The use of a top drive system provides the operator substantial benefits over traditional Kelly drilling.

- Drilling with 90 ft triple stands means fewer drill pipe connections, decreasing drilling time by up to 30%
- Greater control of directional drilling tools provides quicker tool orientation
- Reaming with triple drill pipe lengths leads to faster overall reaming
- Ability to circulate mud and rotate while tripping reduces the risks of stuck drill pipe
- Accurate tool joint make-up extends the life of the drill pipe
- Ability to stab and close IBOP at any time
- Fewer connections and no Kelly bushing at the floor means safer, more efficient drill floors



Technical Specifications of AC Electric Top Drives

Model	TD-250AC	TD-350AC	TD-500AC	TD-750AC	TD-1000AC
Rated Capacity, ton	250	350	500	750	1,000
Rated Power, HP	400	500	800	1,000	1,200
Working Height , ft	19.4	19.4	20	21.3	22.6
Width, ft	3.92	5.04	5.46	5.83	6.88
Max. Continuous Torque, ft-lbs	22,000	29,500	36,900 or 44,300	51,600 or 62,700	62,700
Breakout Torque , ft-lbs	33,200	44,300	55,300 or 66,400	92,200 or 99,600	99,600
Max. Speed, rpm	200	180	220	200	200
Water Course	3 inch at 5,000 psi CWP	3 inch at 5,000 psi CWP	3 inch at 5,000 psi CWP	3-1/2 inch at 7,500 psi CWP	4 inch at 7,500 psi CWP
Type	Portable	Fixed	Fixed	Fixed	Fixed



Handling Tools

A complete line of pipe handling tools for drilling and workover operations. Our product line includes hydraulic power tongs - drill pipe tongs and casing tongs, manual tongs, pneumatic casing elevator/spiders, elevators, elevator links, slips, safety clamps, master bushings and bowel, and roller kelly bushings, etc.



Pneumatic Casing Elevator/Spider



Power Slips



Roller Kelly Bushing



Manual Tong



Casing Slips



Drill Collar Slips

Drilling Equipment

Masts (API-4F)

Cantilever and bootstrap type masts (API-4F) with static hook load 500,000, 750,000, 1,000,000 and 1,500,000 lbs for land and offshore drilling rigs. The cantilever masts are designed to make them easy to move, rig-up and maintain. The bootstrap type masts are specifically designed for applications with limited location size such as offshore platforms and small land sites.



Bootstrap Mast



Cantilever Mast

Substructures (API-4F)

Box-on-box, slingshot and swing-lift type substructures (API-4F) with load capacity 500,000, 750,000, 1,000,000 and 1,500,000 lbs. Slingshot and swing-lift are self-elevating substructures. Slingshot is one of the most popular substructures in the industry.



Box-on-Box Substructure



Slingshot Substructure



Swing-lift Substructure



Drawworks

1000 HP, 1500 HP, 2000 HP, 3000 HP AC and DC electric drawworks and 750 ~ 2000 HP mechanical drawworks.



2000 HP AC Drawworks



1500 HP DC Drawworks



1000 HP Mechanical Drawworks

Crown Blocks



Technical Specifications of Crown Blocks (API-4F)

Model	SD-CB150	SD-CB250	SD-CB350	SD-CB500	SD-CB650
Static Hook Load, ton	150	250	350	500	650
Number of Sheaves	5	6	7	7	8
Sheave Diameter, in	36	44	50	60	60
Wire Rope Diameter, in	1-1/8	1-1/4	1-3/8	1-1/2	1-5/8
Dimensions (LxWxH), in	98x81x76	107x104x126	115x85x94	121x115x141	121x118x142
Weight, lbs	5,280	10,560	13,850	20,950	22,050



Hook Blocks



Technical Specifications of Hook Blocks (API-8C)

Model	SD-HB150	SD-HB175	SD-HB200	SD-HB250	SD-HB350	SD-HB500
Maximum Hook Load, ton	150	175	200	250	350	500
Number of Sheaves	4	4	5	5	5	6
Sheave Diameter	30" or 36"	30"	36"	36" or 44"	50"	60"
Wire Rope Diameter	1" or 1-1/8"	1-1/8"	1-1/8"	1-1/8" or 1-1/4"	1-1/4"	1-3/8"
Dimensions (LxWxH), in	122x39x26	121x33x30	134x38x29	146x47x31	165x53x35	193x63x32
Weight, lbs	7,550	7,230	10,120	14,550	23,940	27,620

Traveling Blocks



Technical Specifications of Traveling Blocks (API-8C)

Model	SD-TB200	SD-TB250	SD-TB350	SD-TB500
Maximum Hook Load, ton	200	250	350	500
Number of Sheaves	5	5	6	6
Sheave Diameter, in	36	44	50	60
Wire Rope Diameter, in	1-1/8	1-3/8	1-3/8	1-1/2
Dimensions (LxWxH), in	83x38x25	90x47x25	106x53x38	121x63x32
Approximate Weight, lbs	6,170	8,180	15,080	17,930



Hooks



Technical Specifications of Hooks (API-8C)

Model	SD-H200	SD-H250	SD-H350	SD-H500
Maximum Hook Load, ton	200	250	350	500
Hook Opening, in	7.5	7.5	8.7	8.7
Dimensions (LxWxH), in	98x29x27	100x31x30	116x35x33	16x35x35
Weight, lbs	4,630	4,800	7,520	7,720

Rotary Tables

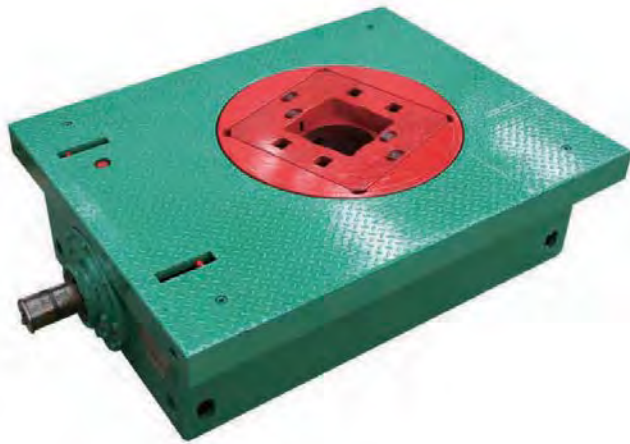

Technical Specifications of Rotary Tables (API-7K)

Model	SD-RT175	SD-RT205A	SD-RT205B	SD-RT275	SD-RT375	SD-RT495
Diameter of Opening	17½"	20½"	20½"	27½"	37½"	49½"
Center of Table to Centerline of Sprocket Teeth	44"	53¼"	44"	53¼"	53¼"	65"
Maximum Static Load, ton	300	350	350	500	650	800
Max Speed, rpm	300	300	300	300	300	300
Gear Ratio	3.75	3.79	3.79	3.67	3.56	3.93
Dimensions (LxWxH), in	78x54x22	87x56x24	78x56x24	94x66x27	97x71x28	116x86x32
Approximate Weight, lbs	8,080	12,220	12,020	13,500	17,570	25,630



Swivels



Technical Specifications of Swivels (API-8C)

Type	SD-S150	SD-S200	SD-S250	SD-S500
Static Hook Load, ton	150	200	250	500
Working Pressure, psi	5,000	5,000	5,000	5,000
Maximum Speed, rpm	300	300	300	300
Coupling Thread to Stem	4-1/2" Reg LH	4-1/2" Reg LH	6-5/8" Reg LH	7-5/8" Reg LH
Coupling Thread to Kelly	6-5/8" Reg LH	6-5/8" Reg LH	6-5/8" Reg LH	6-5/8" Reg LH
Stem I.D.	2-1/2"	2-1/2"	3"	3"
Dimensions (LxWxH), in	90x26x25	107x33x31	117x39x39	120x44x43
Weight, lbs	1,710	2,750	5,510	6,390

Drilling Motors

A full line of AC and DC drilling motors for SCR and VFD electric drilling rigs. Our model SDM-800DC DC drilling motor is an identical match of GE752 traction motor. It has the same footprint and is interchangeable with it. Our AC drilling motors are similar with GEB22 drilling motors but with more models and options. The typical application of our traction motors in drilling industry includes mud pumps, drawworks, and rotary tables.



SDM-800DC Drilling Motor

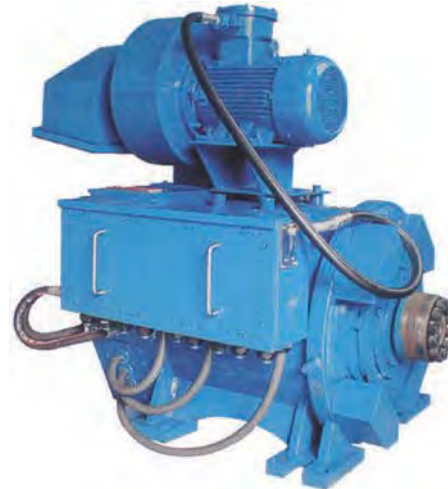

SDM-600AC Drilling Motor

Technical Specifications of Drilling Motors

Model	SDM-800DC	SDM-600AC	SDM-800AC	SDM-1200AC
Type	DC	AC	AC	AC
Application	Mud Pump Drawworks Rotary Table	Mud Pump Drawworks Rotary Table	Mud Pump Drawworks Rotary Table	Mud Pump Drawworks Rotary Table
Maximum Continuous HP	1,085	800	1,085	1,600
Full Load RPM	965	660	740	1000
Full Load Current	1,150	715	915	1355
Voltage	750 vdc	600 vac	600 vac	600 vac



Downhole Tools

A complete line of downhole tools including drill collars, downhole motors, hydraulic and mechanical drilling jars, shock subs, stabilizers, reamers, hole openers, and drill bits, etc.



Drilling Jars



Stabilizer



Hole Opener

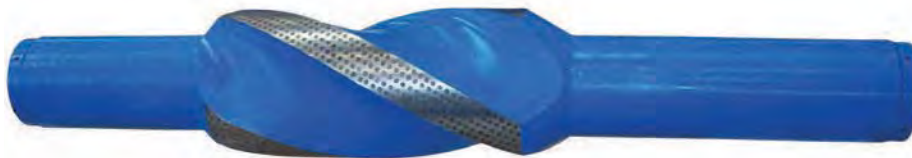

Stabilizers

Oil Country Tubular Goods

Drill Pipe



Drill Pipe Specifications (API-5D)

Pipe						Tool Joint				
Size OD, in.	Nominal Weight, lb/ft	Upset Type	Grade	Wall Thickness, in.	ID, in.	Connection Type	OD, in.	ID, in.	Pin Tong Space*, in.	Box Tong Space*, in.
2-3/8	6.65	EU	E-75	0.280	1.815	NC26	3-3/8	1-3/4	9	10
			X-95	0.280	1.815	NC26	3-3/8	1-3/4	9	10
			G-105	0.280	1.815	NC26	3-3/8	1-3/4	9	10
			S-135	0.280	1.815	NC26	3-5/8	1-3/4	9	10
2-7/8	10.40	EU	E-75	0.362	2.151	NC31	4-1/8	2-1/8	9	11
			X-95	0.362	2.151	NC31	4-1/8	2	9	11
			G-105	0.362	2.151	NC31	4-1/8	2	9	11
			S-135	0.362	2.151	NC31	4-3/8	1-5/8	9	11
3-1/2	13.30	EU	E-75	0.368	2.764	NC38	4-3/4	2-11/16	10	12-1/2
			X-95	0.368	2.764	NC38	5	2-9/16	10	12-1/2
			G-105	0.368	2.764	NC38	5	2-7/16	10	12-1/2
			S-135	0.368	2.764	NC38	5	2-1/8	10	12-1/2
	15.50	EU	E-75	0.449	2.602	NC38	5	2-9/16	10	12-1/2
			X-95	0.449	2.602	NC38	5	2-7/16	10	12-1/2
			G-105	0.449	2.602	NC38	5	2-1/8	10	12-1/2
			S-135	0.449	2.602	NC40	5-1/2	2-1/4	9	12



		Pipe				Tool Joint				
Size OD, in.	Nominal Weight, lb/ft	Upset Type	Grade	Wall Thickness, in.	ID, in.	Connection Type	OD, in.	ID, in.	Pin Tong Space*, in.	Box Tong Space*, in.
4	14.00	IU	E-75	0.330	3.340	NC40	5-1/4	2-13/16	9	12
			X-95	0.330	3.340	NC40	5-1/4	2-11/16	9	12
			G-105	0.330	3.340	NC40	5-1/2	2-7/16	9	12
			S-135	0.330	3.340	NC40	5-1/2	2-7/16	9	12
		EU	E-75	0.330	3.340	NC46	6	3-1/4	9	12
			X-95	0.330	3.340	NC46	6	3-1/4	9	12
			G-105	0.330	3.340	NC46	6	3-1/4	9	12
			S-135	0.330	3.340	NC46	6	3	9	12
	15.70	IU	E-75	0.380	3.240	NC40	5-1/4	2-11/16	9	12
			X-95	0.380	3.240	NC40	5-1/4	2-7/16	9	12
			G-105	0.380	3.240	NC40	5-1/2	2-7/16	9	12
			S-135	0.380	3.240	NC40	5-1/2	2	9	12
		EU	E-75	0.380	3.240	NC46	6	3-1/4	9	12
			X-95	0.380	3.240	NC46	6	3-1/4	9	12
			G-105	0.380	3.240	NC46	6	3-1/4	9	12
			S-135	0.380	3.240	NC46	6	3	9	12
4-1/2	16.60	IEU	E-75	0.337	3.826	NC46	6-1/4	3	9	12
			X-95	0.337	3.826	NC46	6-1/4	3-1/4	9	12
			G-105	0.337	3.826	NC46	6-1/4	3	9	12
			S-135	0.337	3.826	NC46	6-1/4	2-3/4	9	12
		EU	E-75	0.337	3.826	NC50	6-5/8	3-3/4	9	12
			X-95	0.337	3.826	NC50	6-5/8	3-3/4	9	12
			G-105	0.337	3.826	NC50	6-5/8	3-3/4	9	12
			S-135	0.337	3.826	NC50	6-5/8	3-1/2	9	12
	20.00	IEU	E-75	0.430	3.640	NC46	6-1/4	3	9	12
			X-95	0.430	3.640	NC46	6-1/4	2-3/4	9	12
			G-105	0.430	3.640	NC46	6-1/4	2-1/2	9	12
			S-135	0.430	3.640	NC46	6-1/4	2-1/4	9	12
		EU	E-75	0.430	3.640	NC50	6-5/8	3-5/8	9	12
			X-95	0.430	3.640	NC50	6-5/8	3-1/2	9	12
			G-105	0.430	3.640	NC50	6-5/8	3-1/2	9	12
			S-135	0.430	3.640	NC50	6-5/8	3	9	12

Oil Country Tubular Goods

Pipe						Tool Joint				
Size OD, in.	Nominal Weight, lb/ft	Upset Type	Grade	Wall Thickness, in.	ID, in.	Connection Type	OD, in.	ID, in.	Pin Tong Space*, in.	Box Tong Space*, in.
5	19.50	IEU	E-75	0.362	4.276	NC50	6-5/8	3-3/4	9	12
			X-95	0.362	4.276	NC50	6-5/8	3-1/2	9	12
			G-105	0.362	4.276	NC50	6-5/8	3-1/4	9	12
			S-135	0.362	4.276	NC50	6-5/8	2-3/4	9	12
			E-75	0.362	4.276	5-1/2 FH	7	3-3/4	10	12
			X-95	0.362	4.276	5-1/2 FH	7	3-3/4	10	12
			G-105	0.362	4.276	5-1/2 FH	7	3-3/4	10	12
			S-135	0.362	4.276	5-1/2 FH	7-1/4	3-1/2	10	12
	25.60	IEU	E-75	0.500	4.000	NC50	6-5/8	3-1/2	9	12
			X-95	0.500	4.000	NC50	6-5/8	3	9	12
			G-105	0.500	4.000	NC50	6-5/8	2-3/4	9	12
			S-135	0.500	4.000	NC50	6-5/8	2-3/4	9	12
			E-75	0.500	4.000	5-1/2 FH	7	3-1/2	10	12
			X-95	0.500	4.000	5-1/2 FH	7	3-1/2	10	12
			G-105	0.500	4.000	5-1/2 FH	7-1/4	3-1/2	10	12
			S-135	0.500	4.000	5-1/2 FH	7-1/4	3-1/4	10	12
5-1/2	21.90	IEU	E-75	0.361	4.778	5-1/2 FH	7	4	10	12
			X-95	0.361	4.778	5-1/2 FH	7	3-3/4	10	12
			G-105	0.361	4.778	5-1/2 FH	7-1/4	3-1/2	10	12
			S-135	0.361	4.778	5-1/2 FH	7-1/2	3	10	12
	24.70	IEU	E-75	0.415	4.670	5-1/2 FH	7	4	10	12
			X-95	0.415	4.670	5-1/2 FH	7-1/4	3-1/2	10	12
			G-105	0.415	4.670	5-1/2 FH	7-1/4	3-1/2	10	12
			S-135	0.415	4.670	5-1/2 FH	7-1/2	3	10	12
6-5/8	25.20	IEU	E-75	0.330	5.965	6-5/8 FH	8	5	10	13
			X-95	0.330	5.965	6-5/8 FH	8	5	10	13
			G-105	0.330	5.965	6-5/8 FH	8-1/4	4-3/4	10	13
			S-135	0.330	5.965	6-5/8 FH	8-1/2	4-1/4	10	13
	27.70	IEU	E-75	0.362	5.901	6-5/8 FH	8	5	10	13
			X-95	0.362	5.901	6-5/8 FH	8-1/4	4-3/4	10	13
			G-105	0.362	5.901	6-5/8 FH	8-1/4	4-3/4	10	13
			S-135	0.362	5.901	6-5/8 FH	8-1/2	4-1/4	10	13

*2" longer than standard.



Heavy Weight Drill Pipes

Welded and integral heavy weight drill pipes; their sizes are from 3-1/2 to 6-5/8 inches.



Heavy Weight Drill Pipe Specifications* (API-7-1)

Outside Diameter, in.	Inside Diameter, in.	Connection	Tool Joint OD , in.	Tool Joint ID , in.	Center Upset Diameter, in.
3-1/2	2-1/4	NC38	4-3/4 (4-7/8, 5)	2-1/4	4
	2-1/16			2-1/16	
4	2-1/2	NC40	5-1/4	2-1/2	4-1/2
	2-9/16			2-9/16	
4-1/2	2-11/16	NC46	6-1/4	2-11/16	5
	2-3/4			2-3/4	
	2-13/16			2-13/16	
5	3	NC50	6-5/8	3	5-1/2
5-1/2	3-1/4	5-1/2FH	7 (7-1/4, 7-1/2)	3-1/4	6
	3-3/8			3-3/8	
	3-7/8			3-7/8	
	4			4	
6-5/8	4	6-5/8FH	8 (8-1/4, 8-1/2)	4	7-1/8
	4-1/2			4-1/2	
	5			5	

*For both integral and welded heavy weight drill pipes.

Drill Collars

Slick drill collars, spiral drill collars and non-magnetic drill collars; their sizes are from 3-1/8 to 11 inches. Besides the drill collars in the table below, we can supply other drill collars at customers' request.



Drill Collar Specifications (API-7-1)

Drill Collar Number*	Outside Diameter, in.	Inside Diameter, in.	Length, ft	Approximate Weight, lb/ft	Typical Bending Strength Ratio
NC 23-31	3-1/8	1-1/4	30	22	2.57:1
NC 26-35 (2-3/8 IF)	3-1/2	1-1/2	30	27	2.42:1
NC 31-41 (2-7/8 IF)	4-1/8	2	30 or 31	34	2.43:1
NC 35-47	4-3/4	2	30 or 31	47	2.58:1
NC 38-50 (3-1/2 IF)	5	2-1/4	30 or 31	54	2.38:1
NC 44-60	6	2-1/4	30 or 31	83	2.49:1
NC 44-60	6	2-13/16	30 or 31	76	2.84:1
NC 44-62	6-1/4	2-1/4	30 or 31	91	2.91:1
NC 46-62 (4 IF)	6-1/4	2-13/16	30 or 31	84	2.63:1
NC 46-65 (4 IF)	6-1/2	2-1/4	30 or 31	100	2.76:1
NC 46-65 (4 IF)	6-1/2	2-13/16	30 or 31	93	3.05:1
NC 46-67 (4 IF)	6-3/4	2-1/4	30 or 31	109	3.18:1
NC 50-70 (4-1/2 IF)	7	2-1/4	30 or 31	118	2.54:1
NC 50-70 (4-1/2 IF)	7	2-13/16	30 or 31	111	2.73:1
NC 50-72 (4-1/2 IF)	7-1/4	2-13/16	30 or 31	120	3.12:1
NC 56-77	7-3/4	2-13/16	30 or 31	140	2.70:1
NC 56-80	8	2-13/16	30 or 31	151	3.02:1
6-5/8 API Reg	8-1/4	2-13/16	30 or 31	162	2.93:1
NC 61-90	9	2-13/16	30 or 31	196	3.17:1
7-5/8 API Reg	9-1/2	3	30 or 31	217	2.81:1
NC 70-97	9-3/4	3	30 or 31	230	2.57:1
NC 70-100	10	3	30 or 31	243	2.81:1
8-5/8 API Reg	11	3	30 or 31	300	2.84:1

*The number connection (NC) is an API connection with the V- .065 thread form with a V- .038R thread root radius. The first two digits are the pitch diameter of the thread and the last two digits are the outside diameter of the drill collar.

Seamless Casing



Seamless Casing Specifications (API-5CT)

Outside Diameter in.	Nominal Weight lb/ft	Wall Thickness in.	Grade and Connection Type*					
			J55 K55	M65	L80 C95	N80	C90 T95	P110
4-1/2	9.50	0.205	PS	PS	-	-	-	-
	10.50	0.224	PSB	PSB	-	-	-	-
	11.60	0.250	PSLB	PLB	PLB	PLB	PLB	PLB
	13.50	0.290	-	PLB	PLB	PLB	PLB	PLB
	15.10	0.337	-	-	-	-	-	PLB
5	11.50	0.220	PS	PS	-	-	-	-
	13	0.253	PSL	PSLB	-	-	-	-
	15.00	0.296	PSLB	PLB	PSLB	PSLB	PSLB	PSLB
	18.00	0.362	-	PLB	PSLB	PSLB	PSLB	PSLB
	21.40	0.437	-	PLB	PLB	PLB	PLB	PLB
	23.20	0.478	-	-	PLB	PLB	PLB	PLB
	24.10	0.500	-	-	PLB	PLB	PLB	PLB

Oil Country Tubular Goods

Outside Diameter in.	Nominal Weight lb/ft	Wall Thickness in.	Grade and Connection Type*					
			J55 K55	M65	L80 C95	N80	C90 T95	P110
5-1/2	14.00	0.244	PS	PS	-	-	-	-
	15.50	0.275	PSLB	PSLB	-	-	-	-
	17.00	0.304	PSLB	PLB	PSLB	PSLB	PLB	PSLB
	20.00	0.361	-	PLB	PSLB	PSLB	PLB	PSLB
	23.00	0.415	-	PLB	PSLB	PSLB	PLB	PSLB
6-5/8	20.00	0.288	PSLB	PSLB	-	-	-	-
	24.00	0.352	PSLB	PLB	PSLB	PSLB	PSLB	PSLB
	28.00	0.417	-	PLB	PSLB	PSLB	PSLB	PSLB
	32.00	0.475	-	-	PSLB	PSLB	PSLB	PSLB
7	20.00	0.272	PS	PS	-	-	-	-
	23.00	0.317	PSLB	PLB	PSLB	PSLB	PLB	-
	26.00	0.362	PSLB	PLB	PSLB	PSLB	PLB	PSLB
	29.00	0.408	-	PLB	PSLB	PSLB	PLB	PSLB
	32.00	0.453	-	PLB	PSLB	PSLB	PLB	PSLB
	35.00	0.498	-	-	PSLB	PSLB	PLB	PSLB
	38.00	0.540	-	-	PSLB	PSLB	PLB	PSLB
7-5/8	26.40	0.328	PSLB	PSLB	PLB	PLB	PLB	-
	29.70	0.375	-	PLB	PLB	PLB	PLB	PLB
	33.70	0.430	-	PLB	PLB	PLB	PLB	PLB
	39.00	0.500	-	-	PLB	PLB	PLB	PLB
	42.80	0.562	-	-	PLB	PLB	PLB	PLB
	45.30	0.595	-	-	PLB	PLB	PLB	PLB
	47.10	0.625	-	-	PLB	PLB	PLB	PLB



Outside Diameter in.	Nominal Weight lb/ft	Wall Thickness in.	Grade and Connection Type*					
			J55 K55	M65	L80 C95	N80	C90 T95	P110
8-5/8	24.00	0.264	PS	PS	-	-	-	-
	28.00	0.304	-	PS	-	-	-	-
	32.00	0.352	PSLB	PSLB	-	-	-	-
	36.00	0.400	PSLB	PSLB	PLB	PLB	PLB	-
	40.00	0.450	-	PLB	PLB	PLB	PLB	PLB
	44.00	0.500	-	-	PLB	PLB	PLB	PLB
	49.00	0.557	-	-	PLB	PLB	PLB	PLB
9-5/8	36.00	0.352	PSLB	PSLB	-	-	-	-
	40.00	0.395	PSLB	PSLB	PLB	PLB	PLB	-
	43.50	0.435	-	PLB	PLB	PLB	PLB	PLB
	47.00	0.472	-	PLB	PLB	PLB	PLB	PLB
	53.50	0.545	-	-	PLB	PLB	PLB	PLB
	58.40	0.595	-	-	PLB	PLB	PLB	PLB
10-3/4	40.50	0.350	PSB	PSB	PLB	PLB	PLB	PLB
	45.50	0.400	PSB	PSB	-	-	-	-
	51.00	0.450	PSB	PSB	PSB	PSB	PSB	PSB
	55.50	0.495	-	PSB	PSB	PSB	PSB	PSB
	60.70	0.545	-	-	-	-	PSB	PSB
	65.70	0.595	-	-	-	-	PSB	PSB
13-3/8	54.50	0.380	PSB	PSB	-	-	PSB	PSB
	61.00	0.430	PSB	PSB	-	-	-	-
	68.00	0.480	PSB	PSB	PSB	PSB	PSB	PSB
	72.00	0.514	-	-	-	-	PSB	PSB
20	94.00	0.438	SLB	SLB	-	-	-	-
	106.50	0.500	SLB	SLB	-	-	-	-
	133.00	0.635	SLB	-	-	-	-	-

* Premium connections are available on request. P - plain end, S - short round thread, B - butress, L - long round thread.

ERW Casing (API-5CT)

Outside Diameter, in	Nominal Weight, lb/ft	Wall Thickness, in.	Grade	Connection Type*
5-1/2	14.00	0.244	J55/K55	PS
	15.50	0.275	J55/K55	PSLB
	17.00	0.304	J55/K55	PSLB
6-5/8	24.00	0.352	J55/K55	PSLB
7	20.00	0.272	J55/K55	PS
	23.00	0.317	J55/K55	PSLB
	26.00	0.362	J55/K55	PSLB
8-5/8	24.00	0.264	J55/K55	PS
	28.00	0.304	J55/K55	PS
	32.00	0.352	J55/K55	PSLB
	36.00	0.400	J55/K55	PSLB
9-5/8	36.00	0.352	J55/K55	PSLB
	40.00	0.395	J55/K55	PSLB
10-3/4	40.50	0.350	J55/K55	PSB
	45.50	0.400	J55/K55	PSB
13-3/8	48.00	0.330	J55/K55	PSB
	54.50	0.380	J55/K55	PSB
	61.00	0.430	J55/K55	PSB
	68.00	0.480	J55/K55	PSB

* P - plain end, S - short round thread, B - butress, L - long round thread.



Tubing (API-5CT)



Outside Diameter in.	Wall Thickness in.	Weight Non-Upset T&C lb/ft	Weight External Upset T&C lb/ft	Grade and Upset Type*				
				J55	L80	N80	C90	P110
2-3/8	0.167	4.00	-	PN	PN	PN	PN	-
	0.190	4.60	4.70	PNU	PNU	PNU	PNU	PNU
	0.254	5.80	5.95	-	PNU	PNU	PNU	PNU
	0.336	7.35	7.45	PU	-	PU	PU	-
2-7/8	0.217	6.40	6.50	PNU	PNU	PNU	PNU	PNU
	0.276	7.80	7.90	-	PNU	PNU	PNU	PNU
	0.308	8.60	8.70	-	PNU	PNU	PNU	PNU
	0.340	9.35	9.45	-	PU	-	PU	-
	0.440	11.50	-	N	PN	-	PN	-
3-1/2	0.216	7.70	-	PN	PN	PN	PN	-
	0.254	9.20	9.30	PNU	PNU	PNU	PNU	PNU
	0.289	10.20	-	PN	PN	PN	PN	-
	0.375	12.70	12.95	-	PNU	PNU	PNU	PNU
4	0.226	9.50	-	PN	PN	PN	PN	-
	0.262	-	11.00	PU	PU	PU	PU	-
4-1/2	0.271	12.60	12.75	PNU	PNU	PNU	PNU	-

* Premium connections are available on request. P - plain end, N - non-upset, E - external upset.

Production Products

Wellheads & Christmas Tree Components

FC Gate Valves

FC type gate valve has a non-rising stem with a slab gate, floating seat ring body bushing design to provide safe dependable services. The standard features of FC gate valves include full-bore thru-conduit design and metal to metal seals between body and bonnet, gate and seat, and seat and body. The above features make it ideally suited for drilling manifold and production operations. Materials and trims are available for all operating conditions. It is available in flanged ends in standard bore sizes from 1-13/16" through 7-1/16" in working pressures from 2,000 psi to 20,000 psi.

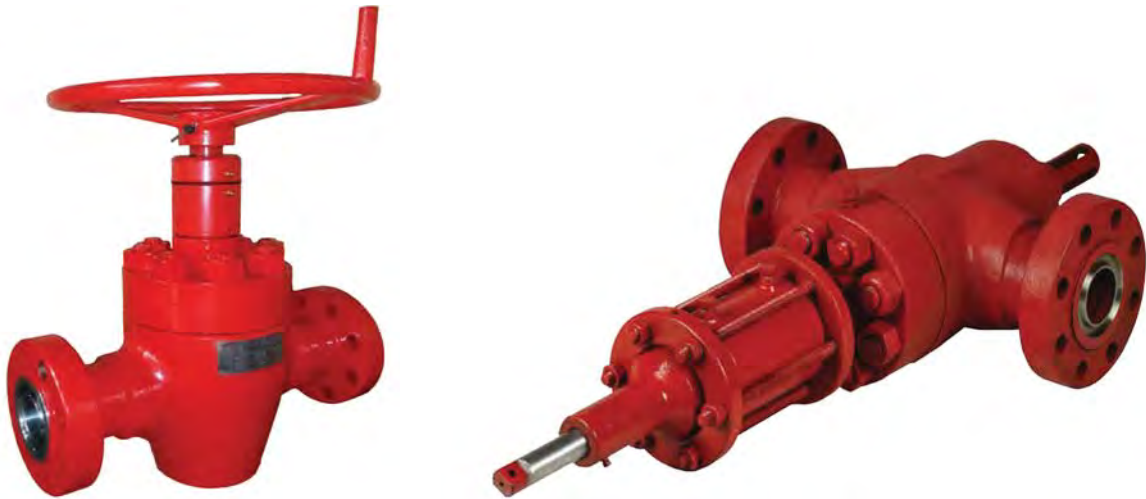

FC Gate Valve Availability

Working Pressure, psi	Nominal Size (inches)							
	1-13/16	2-1/16	2-9/16	3-1/16	3-1/8	4-1/16	5-1/8	7-1/16
2,000								
3,000								
5,000								
10,000								
15,000								
20,000								



Ball screw operator is available for large bore and high pressure gate valves. All of our valves can be actuated by hydraulic or pneumatic actuators.

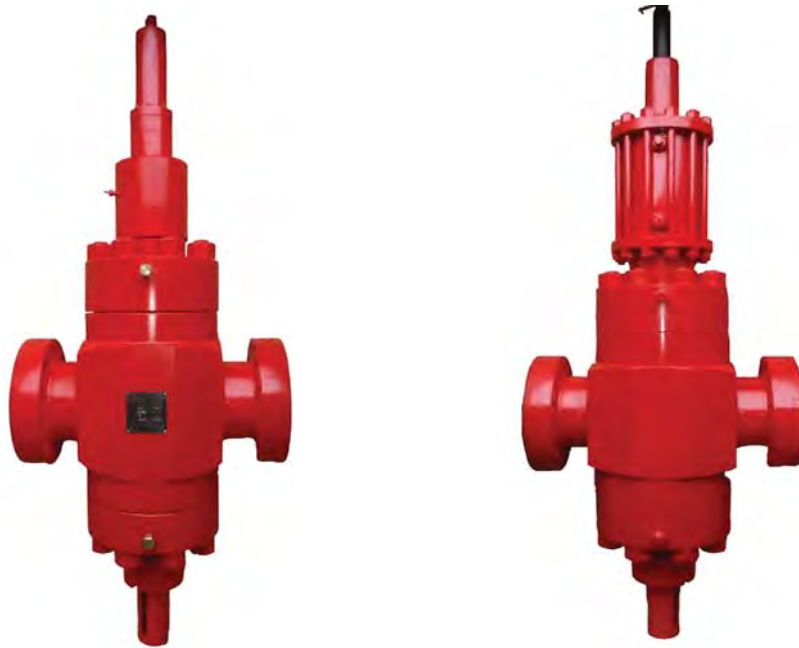

Gate Valve Replacement Parts

Gates, seats, body bushing, bonnet seal rings, stems, stem packings, seat seals, body bushing seals, retainer plates, guides, grease fittings, thrust bearings, etc.



M Expanding Gate Valves

M type expanding gate valve has a non-rising stem with a expanding gate design to provide safe dependable services in a variety of environments. It is available in flanged ends or threaded ends in standard bore sizes from 1-13/16" through 7-1/16" in working pressures from 2,000 psi to 10,000 psi.



M Expanding Gate Valve Availability

Working Pressure, psi	Nominal Size (inches)			
	2-1/16	2-9/16	3-1/8	4-1/16
2,000				
3,000				
5,000				

Chokes

Adjustable and positive chokes.

- Nominal Sizes: 2", 3", 4"
- Needle/Maximum Orifice Size: 1", 2", 3"
- Working Pressure: 2000 through 15,000 psi
- Operating Temperatures: API ratings P, R, S, T, U.



Casing Heads C-22/C-29

C-22 Casing Heads use a straight-bore bowl design that prevents damage to sealing areas from drilling tools and prevents test-plug and bowl-protector wedging problems under pressure. This straightbore design also reduces maintenance costs and permits suspension of heavy casing loads. C-22 Casing Heads normally are furnished with 2-inch threaded outlets, but optional sizes and studded outlets are available upon request. Bottom connections can be furnished slip-on-weld, threaded or slip-n-lock. C-22 Casing Heads permit interchangeability of casing hangers C-22 and C-21.

The C-29 Casing Head uses a straight bore based on the same reliable design as the C-22, except the bowl is 2 inches deeper, permitting the acceptance of the minimal-deflection C-29 Casing Hanger. This allows extreme-load casing-hanging capacity compared with the C-22 profile.

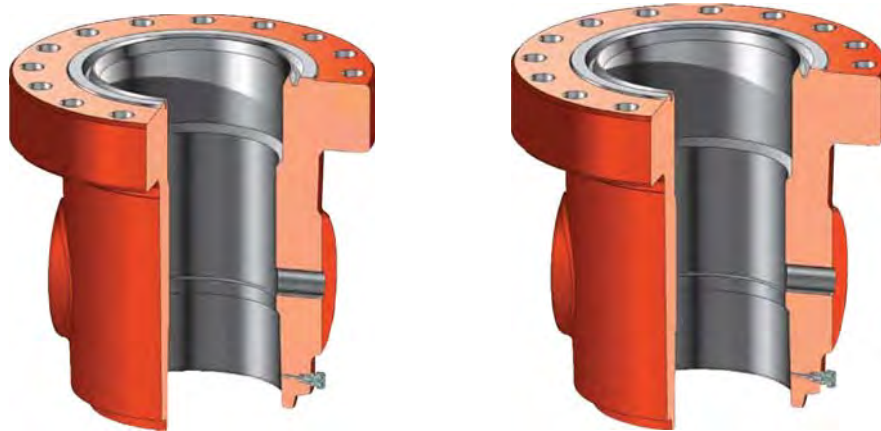

C-22 Casing Head Specifications (API-6A)

Top Flange Size (inches)	Working Pressure (psi)	Casing Size (inches)	Outlet
9"	2,000	7"	2" LP
9"	3,000	7"	2" LP
9"	2,000	7-5/8"	2" LP
9"	3,000	7-5/8"	2" LP
9"	5,000	7-5/8"	2" LP
9"	2,000	8-5/8"	2" LP
9"	3,000	8-5/8"	2" LP
9"	5,000	8-5/8"	2" LP
11"	2,000	8-5/8"	2" LP
11"	3,000	8-5/8"	2" LP
11"	5,000	8-5/8"	2" LP
11"	2,000	9-5/8"	2" LP
11"	3,000	9-5/8"	2" LP
11"	5,000	9-5/8"	2" LP

Wellheads & Christmas Tree Components

Top Flange Size (inches)	Working Pressure (psi)	Casing Size (inches)	Outlet
11"	2,000	7"	2" LP
11"	3,000	7"	2" LP
11"	2,000	7-5/8"	2" LP
13-5/8"	3,000	7-5/8"	2" LP
13-5/8"	5,000	7-5/8"	2" LP
13-5/8"	2,000	8-5/8"	2" LP
13-5/8"	3,000	8-5/8"	2" LP
13-5/8"	5,000	8-5/8"	2" LP
16-3/4"	2,000	8-5/8"	2" LP
16-3/4"	3,000	8-5/8"	2" LP
21-1/4"	5,000	8-5/8"	2" LP
20-3/4"	2,000	9-5/8"	2" LP

C-29 Casing Head Specifications (API-6A)

Top Flange Size (inches)	Working Pressure (psi)	Casing Size (inches)	Outlet
11"	3,000	8-5/8"	LP / SSO
11"	5,000	8-5/8"	LP / SSO
11"	3,000	9-5/8"	LP / SSO
11"	5,000	9-5/8"	LP / SSO
11"	3,000	10-3/4"	LP / SSO
11"	5,000	10-3/4"	LP / SSO
13-5/8"	3,000	13-3/8"	LP / SSO
13-5/8"	5,000	13-3/8"	LP / SSO
16-3/4"	2,000	16"	LP / SSO
16-3/4"	3,000	16"	LP / SSO
16-3/4"	5,000	16"	LP / SSO
21-1/4"	2,000	20"	LP / SSO
20-3/4"	3,000	20"	LP / SSO



Casing Spools C-22/C-29

C-22 Casing Spools are designed with a straightbore bowl that prevents damage to sealing areas from drilling tools and prevents test-plug and bowlprotector wedging problems under pressure. This straight-bore design also reduces maintenance costs and permits suspension of heavy casing loads. C-22 Casing Spools normally are furnished with studded outlets, but optional threaded outlets are available upon request. Bottom preparation can include PE seals or X-bushing secondary seals. HPE seals for high-performance frac wells are available upon request. C-22 Casing Spools allow interchangeability between C-22 and C-21 Casing Hangers.

The C-29 Casing Spool uses a straight bore based on the same reliable design as the C-22 except the bowl is 2 inches deeper, permitting the acceptance of the minimal-deflection C-29 Casing Hanger. This allows extreme-load casing-hanging capacity compared with the C-22 profile. C-29 Casing Spools normally are furnished with studded outlets, and threaded outlets are available upon request. Bottom preparation can include PE seal or X-bushing secondary seals. HPE seals for high-performance frac wells are available upon request..

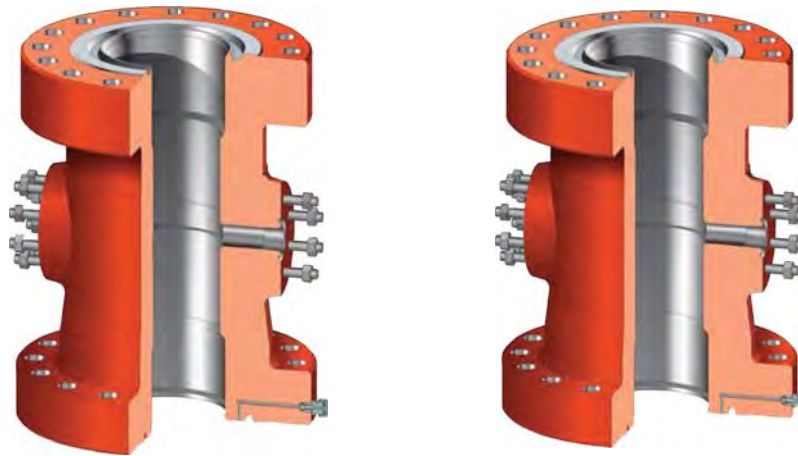

C-22 Casing Spool Specifications (API-6A)

Top Flange Size (inches)	Working Pressure (psi)	Bottom Flange Size (inches)	Working Pressure (psi)
11"	2,000	11"	2,000
11"	2,000	13-5/8"	3,000
11"	3,000	11"	3,000
11"	3,000	11"	2,000
11"	3,000	13-5/8"	2,000
11"	3,000	13-5/8"	3,000
11"	3,000	16-3/4"	2,000
11"	5,000	16-3/4"	3,000
11"	5,000	13-5/8"	3,000
11"	5,000	16-3/4"	3,000
11"	10,000	13-5/8"	5,000
13-5/8"	3,000	16-3/4"	3,000
13-5/8"	3,000	21-1/4"	2,000
13-5/8"	5,000	20-3/4"	3,000

C-29 Casing Spool Specifications (API-6A)

Top Flange Size (inches)	Working Pressure (psi)	Bottom Flange Size (inches)	Working Pressure (psi)
11"	3,000	11"	3,000
11"	3,000	13-5/8"	3,000
11"	3,000	16-3/4"	3,000
11"	5,000	11"	3,000
11"	5,000	13-5/8"	3,000
11"	5,000	13-5/8"	5,000
11"	5,000	16-3/4"	3,000
11"	5,000	16-3/4"	5,000
11"	10,000	11"	10,000
11"	10,000	13-5/8"	5,000
13-5/8"	3,000	20-3/4"	3,000
13-5/8"	5,000	20-3/4"	3,000



Tubing Heads & Spools TCM

TCM Tubing Heads & Spool use a straight-bore bowl design for single and multiple completions in working pressures through 15,000 psi and in sizes to meet all multiple-completion requirements Bottom preparation can include PE seal or X-bushing secondary seals. HPE seals for high-performance frac wells are available upon request.

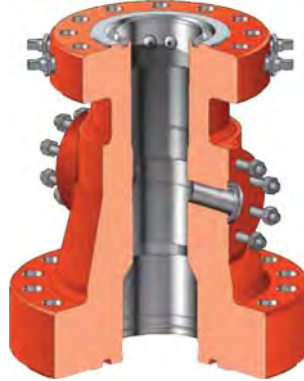

TCM Tubing Head Specifications (API-6A)

Top Flange Size (inches)	Working Pressure (psi)	Bottom Flange Size (inches)	Working Pressure (psi)
7-1/16"	3,000	11"	2,000
7-1/16"	3,000	11"	3,000
7-1/16"	3,000	13-5/8"	2,000
7-1/16"	3,000	13-5/8"	3,000
7-1/16"	5,000	11"	3,000
7-1/16"	5,000	11"	5,000
7-1/16"	5,000	13-5/8"	3,000
7-1/16"	10,000	11"	5,000
7-1/16"	10,000	11"	10,000
7-1/16"	15,000	11"	10,000
9"	3,000	11"	3,000
9"	3,000	13-5/8"	2,000
9"	3,000	13-5/8"	3,000
9"	5,000	11"	3,000
9"	5,000	13-5/8"	3,000
9"	10,000	11"	5,000
9"	10,000	11"	10,000
11"	10,000	13-5/8"	5,000

Tubing Head Adapters



B1 Tubing Head Adapter



B2P Tubing Head Adapter

B1 Tubing Head Adapter

Flange Size (inches)	Working Pressure (psi)	Threaded Top	Bottom Thread
7-1/16"	2,000	2-3/8" UP TBG	2-3/8" UP TBG
7-1/16"	2,000	2-7/8" UP TBG	2-7/8" UP TBG
7-1/16"	2,000	3-1/2" UP TBG	3-1/2" UP TBG
7-1/16"	3,000	2-3/8" UP TBG	2-3/8" UP TBG
7-1/16"	3,000	2-7/8" UP TBG	2-7/8" UP TBG
7-1/16"	3,000	3-1/2" UP TBG	3-1/2" UP TBG
7-1/16"	5,000	2-3/8" UP TBG	2-3/8" UP TBG
7-1/16"	5,000	2-7/8" UP TBG	2-7/8" UP TBG
7-1/16"	5,000	3-1/2" UP TBG	3-1/2" UP TBG

B2P Tubing Head Adapter

Flange Size (inches)	Working Pressure (psi)	Threaded Top	Bottom Thread
7-1/16"	2,000	2-1/16" 2,000 psi	2-3/8" UP TBG
7-1/16"	3,000	2-1/16" 5,000 psi	2-3/8" UP TBG
7-1/16"	3,000	2-9/16" 5,000 psi	2-7/8" UP TBG
7-1/16"	3,000	3-1/8" 5,000 psi	3-1/2" UP TBG
7-1/16"	5,000	2-1/16" 5,000 psi	2-3/8" UP TBG
7-1/16"	5,000	2-9/16" 5,000 psi	2-7/8" UP TBG
7-1/16"	5,000	3-1/8" 5,000 psi	3-1/2" UP TBG



Crosses & Tees

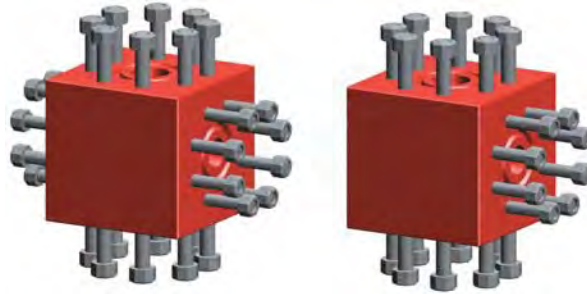

Cross & Tee Specifications

Run Size (inches)	Working Pressure (psi)	Outlet Size (inches)	Working Pressure (psi)
2-1/16"	2,000	2-1/16"	2,000
2-1/16"	5,000	2-1/16"	2,000
2-9/16"	2,000	2-1/16"	2,000
2-9/16"	5,000	2-1/16"	2,000
3-1/8"	2,000	2-1/16"	2,000
3-1/8"	3,000	2-1/16"	5,000
3-1/8"	3,000	3-1/8"	3,000
3-1/8"	5,000	2-1/16"	5,000
3-1/8"	5,000	3-1/8"	5,000
4-1/16"	2,000	2-1/16"	2,000
4-1/16"	2,000	4-1/16"	2,000
4-1/16"	3,000	2-1/16"	5,000
4-1/16"	3,000	4-1/16"	3,000
4-1/16"	5,000	2-1/16"	5,000
4-1/16"	5,000	2-9/16"	5,000
4-1/16"	5,000	3-1/8"	5,000
4-1/16"	5,000	4-1/16"	5,000
1-13/16"	10,000	1-13/16"	10,000
1-13/16"	15,000	1-13/16"	15,000
2-1/16"	10,000	1-13/16"	10,000
2-1/16"	10,000	2-1/16"	10,000
2-1/16"	15,000	1-13/16"	15,000
2-1/16"	15,000	2-1/16"	15,000
2-9/16"	10,000	1-13/16"	10,000
2-9/16"	10,000	2-1/16"	10,000
2-9/16"	10,000	2-9/16"	10,000
2-9/16"	15,000	1-13/16"	15,000
2-9/16"	15,000	2-1/16"	15,000
2-9/16"	15,000	2-9/16"	15,000
3-1/16"	10,000	2-1/16"	10,000
3-1/16"	10,000	2-9/16"	10,000
3-1/16"	10,000	3-1/16"	10,000
4-1/16"	10,000	2-1/16"	10,000
4-1/16"	10,000	3-1/16"	10,000
4-1/16"	10,000	4-1/16"	10,000

Christmas Tree Caps



Christmas Tree Cap (BHTA) Specifications

Bottom Flange Size (inches)	Working Pressure (psi)	Bore (inches)	Lift Thread
2-1/16"	2,000	2-1/16"	2-3/8" EUE
2-1/16"	5,000	2-1/16"	2-3/8" EUE
2-9/16"	2,000	2-9/16"	2-7/8" EUE
2-9/16"	5,000	2-9/16"	2-7/8" EUE
3-1/8"	2,000	2-9/16"	2-3/8" EUE
3-1/8"	2,000	3-1/16"	3-1/2" EUE
3-1/8"	3,000	2-9/16"	2-7/8" EUE
3-1/8"	3,000	3-1/16"	3-1/2" EUE
3-1/8"	5,000	2-9/16"	2-7/8" EUE
3-1/8"	5,000	3-1/16"	3-1/2" EUE
4-1/16"	3,000	4-1/16"	4-1/2" EUE
2-1/16"	10,000	2-1/16"	2-3/8" EUE
2-9/16"	10,000	2-9/16"	2-7/8" EUE
3-1/16"	10,000	3-1/16"	3-1/2" EUE
4-1/16"	10,000	4-1/16"	4-1/2" EUE



Flanges



Flange Size (inches)	Working Pressure (psi)	Outside Diameter	Number of Bolt Holes	Diameter of Bolts	Length of Bolts	API Ring Gasket
1-13/16"	10,000	7-3/8"	8	3/4"	5-1/4"	BX-151
	15,000	8-3/16"	8	7/8"	6"	BX-151
	20,000	10-1/8"	8	1"	7-3/4"	BX-151
2-1/16"	2,000	6-1/2"	8	5/8"	5/8"	R-23
	3,000/5,000	8-1/2"	8	7/8"	7/8"	R-24
	10,000	7-7/8"	8	3/4"	3/4"	BX-152
	15,000	8-3/4"	8	7/8"	7/8"	BX-152
	20,000	11-5/16"	8	1-1/8"	1-1/8"	BX-152
2-9/16"	2,000	7-1/2"	8	3/4"	5-1/4"	R-26
	3,000/5,000	9-5/8"	8	1"	7"	R-27
	10,000	9-1/8"	8	7/8"	6-1/4"	BX-153
	15,000	10"	8	1"	7"	BX-153
	20,000	12-13/16"	8	1-1/4"	9-1/2"	BX-153
3-1/8"	2,000	8-1/4"	8	3/4"	5-1/2"	R-31
	3,000	9-1/2"	8	7/8"	6-1/4"	R-31
	5,000	10-1/2"	8	1-1/8"	7-3/4"	R-35
3-1/16"	10,000	10-5/8"	8	1"	7-1/4"	BX-154
	15,000	11-5/16"	8	1-1/8"	8"	BX-154
	20,000	14-1/16"	8	1-3/8"	10-3/4"	BX-154
4-1/16"	2,000	10-3/4"	8	7/8"	6-1/4"	R-37
	3,000	11-1/2"	8	1-1/8"	7-1/2"	R-37
	5,000	12-1/4"	8	1-1/4"	8-1/2"	R-39
	10,000	12-7/16"	8	1-1/8"	8-3/8"	BX-155
	15,000	14-3/16"	8	1-3/8"	9-3/4"	BX-155
	20,000	17-9/16"	8	1-3/4"	12-3/4"	BX-155
5-1/8"	5,000	14-3/4"	8	1-1/2"	10-3/4"	R-44

Wellheads & Christmas Tree Components

Flange Size (inches)	Working Pressure (psi)	Outside Diameter	Number of Bolt Holes	Diameter of Bolts	Length of Bolts	API Ring Gasket
7-1/16"	2,000	14"	12	1"	7-1/2"	R-45
	3,000	15"	12	1-1/8"	8-1/2"	R-45
	5,000	15-1/2"	12	1-3/8"	11-1/4"	R-46
	10,000	18-7/8"	12	1-1/2"	11-3/4"	BX-156
	15,000	19-7/8"	16	1-1/2"	13"	BX-156
	20,000	25-13/16"	16	2"	17-3/4"	BX-156
9"	2,000	16-1/2"	12	1-1/8"	8-1/2"	R-49
	3,000	18-1/2"	12	1-3/8"	9-1/2"	R-49
	5,000	19"	12	1-5/8"	12-1/2"	R-50
	10,000	21-3/4"	16	1-1/2"	13-1/4"	BX-151
	15,000	25-1/2"	16	1-7/8"	16"	BX-151
11"	2,000	20"	16	1-1/4"	9-1/4"	R-53
	3,000	21-1/2"	16	1-3/8"	10"	R-53
	5,000	23"	12	1-7/8"	14-1/4"	R-54
	10,000	25-3/4"	16	1-3/4"	15-3/8"	BX-158
	15,000	32"	20	2"	19-1/2"	BX-158
13-5/8"	2,000	22"	20	1-1/4"	9-1/2"	R-57
	3,000	24"	20	1-3/8"	10-3/4"	R-57
	5,000	26-1/2"	16	1-5/8"	12-3/4"	BX-160
	10,000	30-1/4"	20	1-7/8"	17-3/4"	BX-159
	15,000	34-7/8"	20	2-1/4"	21"	BX-159
16-3/4"	2,000	27"	20	1-1/2"	10-3/4"	R-65
	3,000	27-3/4"	20	1-5/8"	12-1/4"	R-66
	5,000	30-3/8"	16	1-7/8"	14-3/4"	BX-162
	10,000	34-5/16"	24	1-7/8"	17-3/4"	BX-162
18-3/4"	5,000	35-5/8"	20	2"	18"	BX-163
	10,000	40-15/16"	24	2-1/4"	23"	BX-164
20-3/4"	3,000	33-3/4"	20	2"	15-1/4"	R-74
21-1/4"	2,000	32"	24	1-5/8"	12-1/2"	R-73
	5,000	39"	24	2"	19"	BX-165
	10,000	45"	24	2-1/2"	24-3/4"	BX-166
26-3/4"	2,000	41"	20	1-3/4"	14-1/4"	BX-167
	3,000	43-3/8"	24	2"	17-1/2"	BX-168



Pumping Units

Crank Balanced Pumping Units (API-11E)



Unit Size	Polished Rod Capacity, lbs	Stroke Length, inches	Gear Reducer Peak Torque Rating, in.lbs
C-912D-470-240	47,000	240, 211, 181	912,000
C-912D-427-216	42,700	216, 185, 155	912,000
C-912D-427-192	42,700	192, 165, 138	912,000
C-912D-305-192	30,500	192, 165, 138	912,000
C-912D-365-168	36,500	168, 144, 121	912,000
C-912D-305-168	30,500	168, 144, 121	912,000
C-912D-427-144	42,700	144, 123, 102	912,000
C-640D-305-192	30,500	192, 165, 138	640,000
C-640D-305-168	30,500	168, 144, 121	640,000
C-640D-365-144	36,500	144, 123, 102	640,000
C-640D-305-144	30,500	144, 123, 102	640,000
C-640D-256-144	25,600	144, 123, 102	640,000
C-640D-305-120	30,500	120, 102, 84	640,000
C-456D-305-168	30,500	168, 144, 121	456,000
C-456D-305-144	30,500	144, 123, 102	456,000
C-456D-256-144	25,600	144, 123, 102	456,000
C-456D-365-120	36,500	120, 102, 84	456,000
C-456D-305-120	30,500	120, 102, 84	456,000
C-456D-256-120	25,600	120, 102, 84	456,000
C-320D-256-144	25,600	144, 123, 102	320,000
C-320D-256-120	25,600	120, 102, 84	320,000
C-320D-213-120	21,300	120, 102, 84	320,000

Pumping Units

Unit Size	Polished Rod Capacity, lbs	Stroke Length, inches	Gear Reducer Peak Torque Rating, in.lbs
C-320D-256-144	25,600	144, 123, 102	320,000
C-320D-256-120	25,600	120, 102, 84	320,000
C-320D-213-120	21,300	120, 102, 84	320,000
C-320D-305-100	30,500	100, 85, 70	320,000
C-320D-256-100	25,600	100, 85, 70	320,000
C-320D-213-86	21,300	86, 71, 56	320,000
C-228D-213-120	21,300	120, 102, 84	228,000
C-228D-173-100	17,300	100, 86, 72	228,000
C-228D-246-86	24,600	86, 71, 56	228,000
C-228D-213-86	21,300	86, 71, 56	228,000
C-228D-200-74	20,000	74, 64, 54	228,000
C-228D-173-74	17,300	74, 64, 54	228,000
C-160D-173-86	17,300	86, 74, 62	160,000
C-160D-200-74	20,000	74, 64, 54	160,000
C-160D-173-74	17,300	74, 64, 54	160,000
C-160D-143-74	14,300	74, 64, 54	160,000
C-160D-173-64	17,300	64, 54, 44	160,000
C-114D-119-86	11,900	86, 72, 59	114,000
C-114D-143-74	14,300	74, 62, 51	114,000
C-114D-173-64	17,300	64, 54, 44	114,000
C-114D-143-64	14,300	64, 52, 40	114,000
C-114D-133-54	13,300	54, 45, 36	114,000
C-80D-119-64	11,900	64, 53, 42	80,000
C-80D-133-54	13,300	54, 45, 36	80,000
C-80D-119-54	11,900	54, 45, 36	80,000
C-80D-133-48	13,300	48, 40, 32	80,000
C-80D-109-48	10,900	48, 37, 25	80,000
C-57D-76-54	7,600	54, 41, 28	57,000
C-57D-109-48	10,900	48, 37, 25	57,000
C-57D-95-48	9,500	48, 37, 25	57,000
C-57D-89-42	8,900	42, 33, 23	57,000
C-57D-76-42	7,600	42, 33, 23	57,000
C-40D-76-48	7,600	48, 37, 27	40,000
C-40D-89-42	8,900	42, 33, 23	40,000
C-40D-76-42	7,600	42, 33, 23	40,000
C-40D-89-36	8,900	36, 28, 20	40,000
C-25D-67-36	6,700	36, 28, 20	25,000
C-25D-56-36	5,600	36, 28, 20	25,000
C-25D-53-30	5,300	30, 20	25,000



Beam Balanced Pumping Units (API-11E)



Unit Size	Polished Rod Capacity, lbs	Stroke Length, inches	Gear Reducer Peak Torque Rating, in.lbs
B-80D-119-64	11,900	64, 54	80,000
B-80D-76-64	7,600	64, 54	80,000
B-80D-133-54	13,300	51, 41	80,000
B-80D-119-64	11,900	51, 41	80,000
B-80D-76-54	7,600	51, 41	80,000
B-80D-109-48	10,900	48, 35	80,000
B-57D-109-54	10,900	54, 41	57,000
B-57D-89-54	8,900	54, 41	57,000
B-57D-76-54	7,600	54, 41	57,000
B-57D-109-48	10,900	48, 35	57,000
B-57D-89-48	8,900	48, 35	57,000
B-40D-89-48	8,900	48, 35	40,000
B-40D-76-42	7,600	42, 29	40,000
B-25D-67-36	6,700	36, 27	25,000
B-16D-53-30	5,300	30, 23	16,000

Sucker Rods (API-11B) & Rod Pumps (API-11AX)

Sucker rods include size 5/8", 3/4", 7/8", 1", 1-1/8", 1-1/4" and grade C, D, K, and H. Downhole sucker rod and tubing pumps with various sizes and configurations.





Oilfield Service Products

Frac Components

Frac valves - FC and FLS style, manual, ball screw operated, and hydraulic, size 4-1/16", 5-1/8" and 7-1/16", pressure ratings 5M, 10M, 15M and 20M. Goat heads (frac heads), 4-1/16", 5-1/8" 7-1/16", with 5M, 10M, 15M pressures, 4 or 6 side outlets, and various top bottom studed and flanged connections. Adapter flanges, spools, and other flanges, various sizes and pressure ratings.



BSO Valve

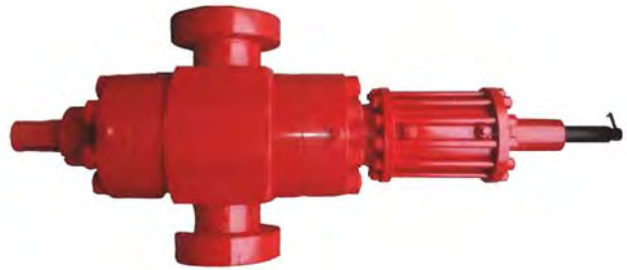

Hydraulic Valve



FC Gate Valve

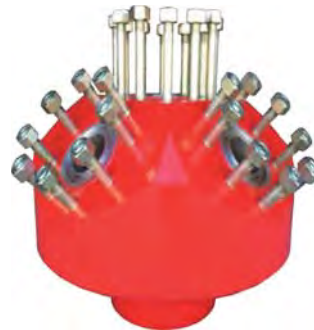

Goat Head



Spacer Spool



Adapter Flange

Flowline Products

Swivel joints, pup joints, hose loops, plug valves, integral fittings, hammer unions, etc.



Swivel Joint



Pup Joint



Plug Valve



Hammer Union



Hose Loop



Integral Fittings



Onshore Workover Rigs



Model	SWR-150	SWR-250	SWR-350	SWR-450
Service Depth (2-7/8" Tubing) , ft	8,500	10,500	13,000	18,000
Workover Depth (2-7/8" Drill Pipe), ft	-	8,500	10,500	14,000
Static Hook Load, lbs	130,000	150,000	200,000	250,000
Number of Lines Stung to The Traveling Block	6	6	8	8
Diameter of Drilling Line, in	7/8	7/8	1	1
Carrier	6 x 6	6 x 6	10 x 8	10 x 8
Drawworks Rated Power, HP	150	250	350	450
Engine	Caterpillar C-7	Caterpillar C-9	Caterpillar C-11	Caterpillar C-13
Transmission	-	Allison OFS4700	Allison OFS4700	Allison S5610
Main Brake	Band	Band	Band	Band/Disc
Auxiliary Brake	-	-	Eaton WCB	Eaton WCB
Mast Type	Single	Single/Telescoping	Telescoping	Telescoping
Mast Height, ft	58	58	95	102
Substructure Type	-	Light Platform	Light Platform	Telescoping
Substructure Height, ft	-	5	9	12
Rotary Table	-	10½"	10½"/17½"	17½"
Hook Block Load, lbs	130,000	150,000	200,000	250,000
Swivel Load, lbs	130,000	150,000	200,000	250,000

Model	SWR-550	SWR-650	SWR-750	SWR-1000
Service Depth, ft	23,000 (2-7/8" Tubing)	28,000 (2-7/8" Tubing)	26,000 (2-7/8" Drill Pipe)	29,000 (2-7/8" Drill Pipe)
Workover Depth (3-1/2" Drill Pipe), ft	15,000	18,000	21,000	24,000
Static Hook Load, lbs	300,000	350,000	400,000	500,000
Number of Lines Stung to The Traveling Block	8	8	8/10	10
Diameter of Drilling Line, in	1	1-1/8	1-1/4	1-1/4
Carrier	10 x 8	12 x 8	14 x 8	14 x 10
Drawworks Rated Power, HP	550	650	750	1,000
Engine	Caterpillar C-15	Caterpillar C-18	Caterpillar C-15 x 2	Caterpillar C-18 x 2
Transmission	Allison S5610	Allison S6610	Allison S5610 x 2	Allison S6610 x 2
Main Brake	Band/Disc	Band/Disc	Band /Disc	Disc
Auxiliary Brake	Eaton WCB	Eaton WCB	Eaton WCB	Eaton WCB
Mast Type	Telescoping	Telescoping	Telescoping	Telescoping
Mast Height, ft	108	115	118/125	118/125
Substructure Type	Telescoping	Telescoping	Foldable	Foldable
Substructure Height, ft	15	15	20	20
Rotary Table	17½"	17½"	20½"/27½"	27½"
Hook Block Load, lbs	300,000	350,000	400,000	500,000
Swivel Load, lbs	300,000	350,000	400,000	500,000





Offshore Drilling and Workover Rigs



Model	SOR-450	SOR-550	SOR-650	SOR-750	SOR-1000
Static Hook Load, lbs	250,000	300,000	350,000	400,000	500,000
Number of Lines Stung to The Traveling Block	6/8	8	8	8 /10	10
Drilling Depth (4-1/2" Drill Pipe), ft	3,300	5,000	6,600	10,000	13,000
Workover Depth (3-1/2" Drill Pipe), ft	11,500	15,000	18,000	21,000	24,000
Mast Height, ft	95	95	95/102/108	102/108	102/108/115
Rotary Table	17½"	17½"	17½"	20½"/27½"	27½"
Hook Block Load, lbs	250,000	300,000	350,000	400,000	500,000
Swivel Load, lbs	250,000	300,000	350,000	400,000	500,000

Well Service Pumps

Well service and stimulation pumps from 350 to 3000 HP for acidizing, cementing, fracturing, and snubbing operations. Many of our service and stimulation pumps are interchangeable with the popular OEM pumps in the industry.



TPP-600S, 600 HP



THT-400, 800 HP



QPP-1000, 1000 HP



QPP-2500, 2500 HP



Cementing Equipment

Truck-mounted, trailer-mounted, and skid-mounted cementing units with single and twin pump configurations and skid-mounted and truck-mounted batch mixing units with automatic mixing system. Our cementing units are equipped with Caterpillar, Detroit, or Cummins diesel engines and single or twin triplex plunger pumps.



Truck-Mounted Cementing Unit



Trailer-Mounted Cementing Unit



Skid-Mounted Cementing Unit

Fracturing Equipment

Fracturing pump, fracturing blender, data van, and support equipment.



Fracturing Pump



Fracturing Blender



Manifolds Trailer



Line Pipes (API-5L)

Line pipes are used to transport oil and gas, water, mineral slurry and other fluids. Our line pipes are manufactured in accordance with API Spec 5L. We supply various line pipes including seamless line pipes (OD from 2-3/8" to 24", steel grade A, B, X42 - X80) and ERW line pipes (OD from 4-1/2" to 20", steel grade A, B, X42 - X80).



Seamless Line Pipes



ERW Production Line



Casing and Tubing Manufacturing Facility



Gate Valves



Mud Pumps

SUNNDA



Sunnda Corporation

Address: 2121 Brittmoore Rd, Suite 4000

Houston, TX 77043

USA

Phone: +1-713-849-5678

Fax: +1-713-849-5687

E-mail: sales@sunnda.com

Website: <http://www.sunnda.com>